

CATALOGO CATALOGUE



PRECISIONE SICUREZZA PROTEZIONE FUNZIONALITÀ SCORREVOLEZZA

GIPIEMME

8 times world champions

COMPONENTI E GRUPPI COMPLETI
COMPONENTS AND COMPLETE GROUPS
BESTANDTEILE UND KOMPLETTE GRUPPEN



Gipiemme srl 36040 Grumolo Abbadesse Loc. Vancimuglio (Vicenza) Tel. 0444/582344 Telex 431142 GPM I

CRONOSPECIAL

PROFESSIONAL "AA"

- 100AA Guarnitura - Crankset - Jeu de pédalier - Tretlager
- 200AB Movimento - Botton Bracket - Axe de pédalier - Innenlager
- 300BB Pedali - Pedal set - Pedales - Pedaler
- 400BB Mozzi - Hub set - Moyeurs - Niederflanschnaben
- 500AA Serie sterzo - Headset - Jeu de direction - Steuersatz
- 600AA Reggisella - Seat post - Tige de selle - Sattelstütze
- 700AA Freni - Brakes - Freins - Bremsen
- 800AES Cambio - Derailleurs - Derailleurs - Schaltung
- 906CC Ruota Libera - Free Wheel - Roue Libre - Freilauf
- 950AS Catena - Chain - Chaîne - Kette
- 1400AA Piantone - Stem - Potence - Vorbau
- 1500AA Manubrio - Handlebar - Cintre - Lenkerbuegel

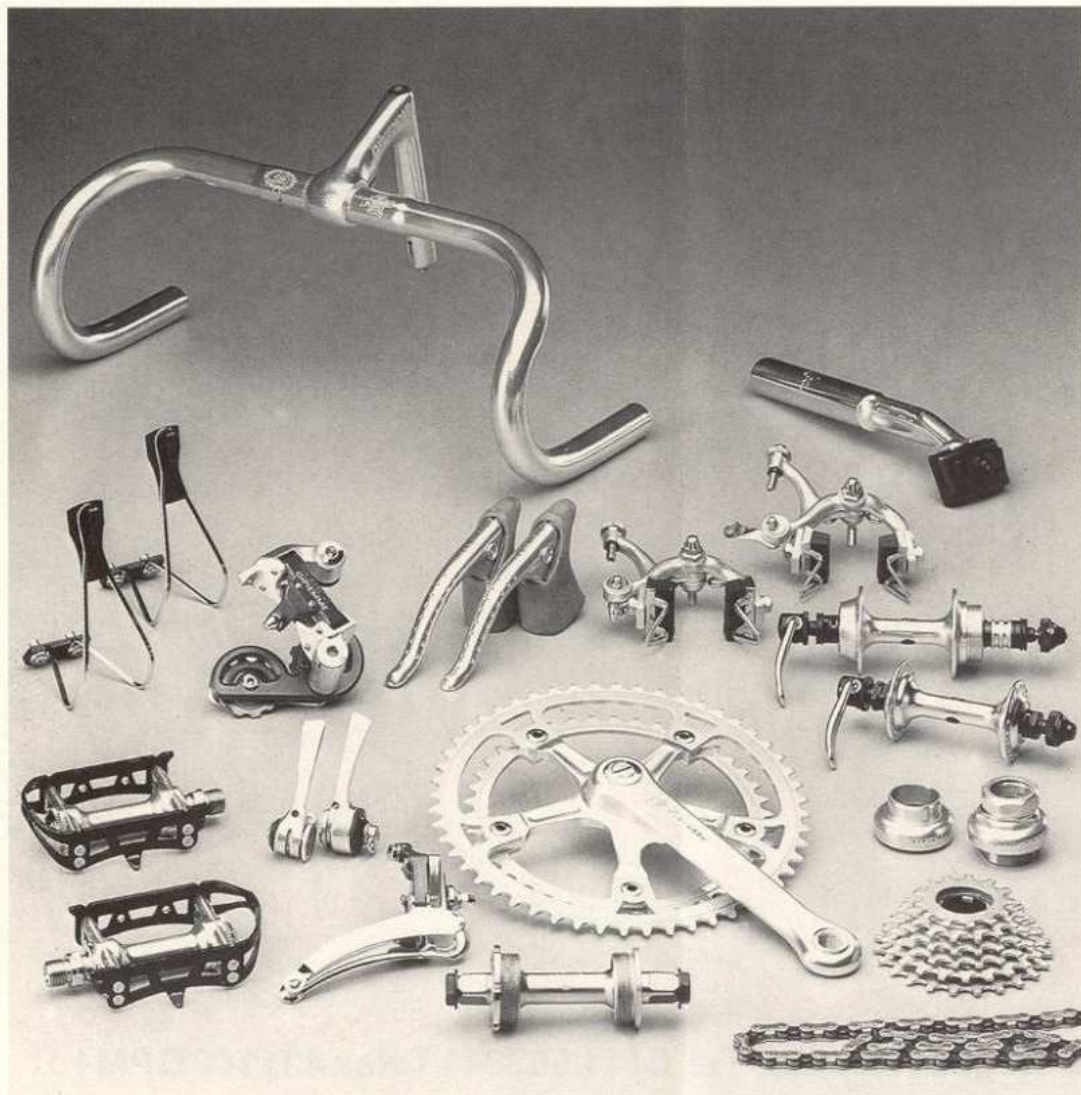

CRONOSPECIAL

PISTA/TRACK/BAHN "B1"

- 100A1 Guarnitura - Crankset - Jeu de pédalier - Tretlager
- 200A1 Movimento - Botton Bracket - Axe de pédalier - Innenlager
- 300B1 Pedali - Pedal set - Pedales - Pedaler
- 400B1 Mozzi - Hub set - Moyeurs - Niederflanschnaben
- 500B1 Serie sterzo - Headset - Jeu de direction - Steuersatz
- 600AA Reggisella - Seat post - Tige de selle - Sattelstütze



CRONOSPRINT

AMATEUR "BA"

SPRINT

JUNIORES "DD"

- 400BA Guarnitura - Crankset - Jeu de pédalier - Tretlager
- 200DS Movimento - Botton Bracket - Axe de pédalier - Innenlager
- 300DD Pedali - Pedal set - Pedales - Pedaler
- 400CA Mozzi - Hub set - Moyeurs - Niederflanschnaben
- 500CA Serie sterzo - Headset - Jeu de direction - Steuersatz
- 600CA Reggisella - Seat post - Tige de selle - Sattelstütze
- 700CA Freni - Brakes - Freins - Bremsen
- 800AE Cambio - Derailleurs - Derailleurs - Schaltung
- 906CE Ruota Libera - Free Wheel - Roue Libre - Freilauf
- 950AS Catena - Chain - Chaîne - Kette
- 1400CC Piantone - Stem - Potence - Vorbau
- 1500CC Manubrio - Handlebar - Cintre - Lenkerbuegel

- 100SB Guarnitura - Crankset - Jeu de pédalier - Tretlager
- 200DS Movimento - Botton Bracket - Axe de pédalier - Innenlager
- 300SA Pedali - Pedal set - Pedales - Pedaler
- 400SA Mozzi - Hub set - Moyeurs - Niederflanschnaben
- 500DS Serie sterzo - Headset - Jeu de direction - Steuersatz
- 600SS Reggisella - Seat post - Tige de selle - Sattelstütze
- 700DD Freni - Brakes - Freins - Bremsen
- 800DD Cambio - Derailleurs - Derailleurs - Schaltung
- 906CE Ruota Libera - Free Wheel - Roue Libre - Freilauf
- 950CC Catena - Chain - Chaîne - Kette
- 1400DD Piantone - Stem - Potence - Vorbau
- 1500DD Manubrio - Handlebar - Cintre - Lenkerbuegel



GUARNITURE

CRANKSET JEU DE PEDALIER TRETLAGER



GPM CRONOSPECIAL 100AA

- Guarnitura strada in lega • Light alloy road crankset
- Jeu de pédalier route • Strassenkettenradgarnitur

Pedivella / Crank / Manivelle / Kurbellaenge
mm. 165 167.5 170 172.5 175

Ingranaggi / Chainrings / Plateau / Kettenblätter

1°	50	51	52	53	54
2°	41	42	43	44	45
3°	28	30	32	34	36

GPM CRONOSPRINT 100CC

- Guarnitura strada in lega • Light alloy road crankset
- Jeu de pédalier route • Strassenkettenradgarnitur

Pedivella / Crank / Manivelle / Kurbellaenge
mm. 170

Ingranaggi / Chainrings / Plateau / Kettenblätter

1°	52	53
2°	42	



GPM SPRINT 100SB

- Guarnitura strada in lega • Light alloy road crankset
- Jeu de pédalier route • Strassenkettenradgarnitur

Pedivella / Crank / Manivelle / Kurbellaenge
mm. 170

Ingranaggi / Chainrings / Plateau / Kettenblätter

1°	52	53
2°	42	

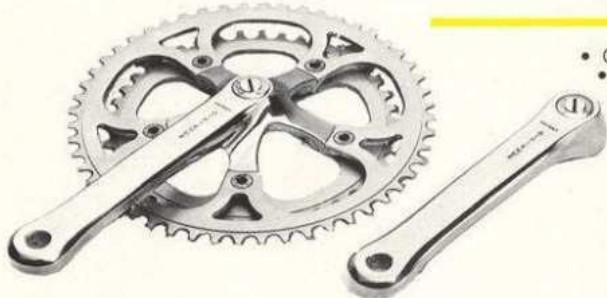

GPM CRONOSPRINT 100BA BAGARRE

- Guarnitura strada in lega • Light alloy road crankset
- Jeu de pédalier route • Strassenkettenradgarnitur

Pedivella / Crank / Manivelle / Kurbellaenge
mm. 170

Ingranaggi / Chainrings / Plateau / Kettenblätter

1°	52	53
2°	42	



GPM CRONOSPECIAL 100AT

- Guarnitura tripla in lega • Light alloy triple crankset
- Jeu de pédalier triple • Dreifachkettenradgarnitur

Pedivella / Crank / Manivelle / Kurbellaenge
mm. 165 167.5 170 172.5 175

Ingranaggi / Chainrings / Plateau / Kettenblätter

1°	50	51	52	53	54
2°	41	42	43	44	45
3°	28	30	32	34	36



GPM CRONOSPRINT 100CT

- Guarnitura tripla in lega • Light alloy triple crankset
- Jeu de pédalier triple • Dreifachkettenradgarnitur

Pedivella / Crank / Manivelle / Kurbellaenge
mm. 170

Ingranaggi / Chainrings / Plateau / Kettenblätter

1°	52	53
2°	42	
3°	28	30
	32	34
	36	



GPM CRONOSPECIAL 100A1

- Guarnitura pista in lega • Light alloy track crankset
- Jeu de pédalier piste • Bahnkettenradgarnitur

Pedivella / Crank / Manivelle / Kurbellaenge
mm. 165 167.5 170 172.5 175

Ingranaggi / Chainrings / Plateau / Kettenblätter

1°	44	45	46	47	48	49	50	51	52	53
----	----	----	----	----	----	----	----	----	----	----

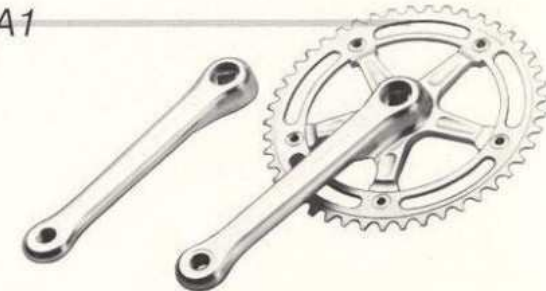

GPM CRONOSPECIAL 100A4

- Guarnitura cross in lega • Light alloy "cross" crankset
- Jeu de pédalier cross • Crosskettenradgarnitur

Pedivella / Crank / Manivelle / Kurbellaenge
mm. 165 167.5 170 172.5 175

Ingranaggi / Chainrings / Plateau / Kettenblätter

1°	42	43	44	45	46	47	48	49	50	51	52
----	----	----	----	----	----	----	----	----	----	----	----

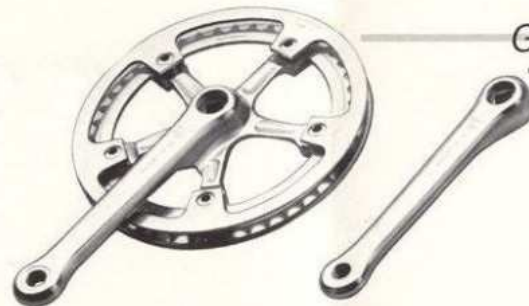

GPM MINISPRINT 100DM

- Guarnitura strada in lega • Light alloy road crankset
- Jeu de pédalier route • Strassenkettenradgarnitur

Pedivella / Crank / Manivelle / Kurbellaenge
mm. 115 125 135 145

Ingranaggi / Chainrings / Plateau / Kettenblätter

1°	41	42	43	44	45	46
2°	35	36	37	38	39	40



MOVIMENTI

BOTTON BRACKET INNENLAGER

GPM CRONOSPECIAL 200AB-200AT-200A4

- Movimento strada (200AB) e triplo (200AT) e cross (200A4) • Road (200AB) triple (200AT) and cross (200A4) botton bracket set • Axe de pédalier route (200AB), triple (200AT) et cross (200A4) • Strasseninnenlager (200AB), Cross (200A4) und dreifachinnenlager (200AT)



GPM CRONOSPECIAL 200A1

- Movimento pista mm. 68 • Track botton bracket set mm. 68 • Axe de pédalier piste mm. 68 • Bahninnenlager mm. 68



GPM SPRINT 200DS

- Movimento strada mm. 68-70 • Road botton bracket set mm. 68-70 • Axe de pédalier route mm. 68-70 • Strasseninnenlager mm. 68-70



REGGISSELLA

SEAT POST TIGE DE SELLE SADDLEPOST

GPM CRONOSPECIAL 600AA

- Reggisella in lega • Light alloy seat post • Tige de selle en alliage léger • Leichtmetall Sattelstütze



GPM CRONOSPRINT 600DD

- Reggisella in lega • Light alloy seat post • Tige de selle en alliage léger • Leichtmetall Sattelstütze

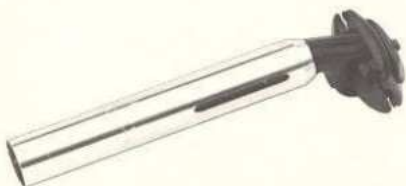

GPM CRONOSPRINT 600BA

- Reggisella in lega • Light alloy seat post • Tige de selle en alliage léger • Leichtmetall Sattelstütze



GPM SPRINT 600SS

- Reggisella in lega • Light alloy seat post • Tige de selle en alliage léger • Leichtmetall Sattelstütze



GPM CRONOSPRINT 600CA

- Reggisella in lega • Light alloy seat post • Tige de selle en alliage léger • Leichtmetall Sattelstütze

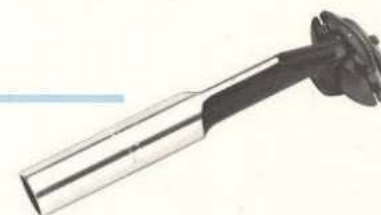

PEDALI

PEDAL SET PEDALES PEDALEN

GPM CRONOSPECIAL 300AX

- Pedali multiasse strada e pista in lega • Light alloy road and track pedal set • Pedales multiaxe route et piste en alliage léger • Leichtmetall Strassenbahnpedalen

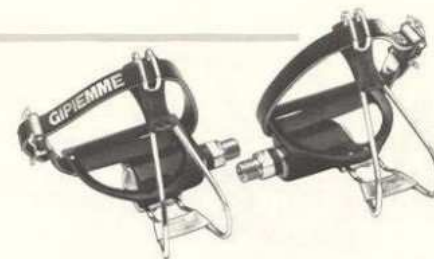

GPM CRONOSPRINT 300CA

- Pedali strada e pista in lega • Light alloy road and track pedal set • Pedales route et piste en alliage léger • Leichtmetall Strassenbahnpedalen



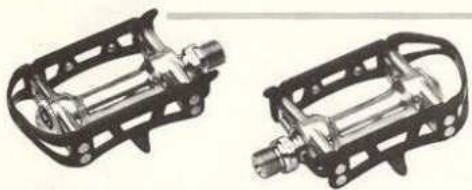

GPM CRONOSPECIAL 300BB

- Pedali strada in lega • Light alloy road pedal set
- Pedales route en alliage léger
- Leichtmetal Strassenpedalen

GPM CONOSPECIAL 300B1

- Pedali pista in lega • Light alloy track pedal set
- Pedales piste en alliage léger
- Leichtmetal Bahnpedalen

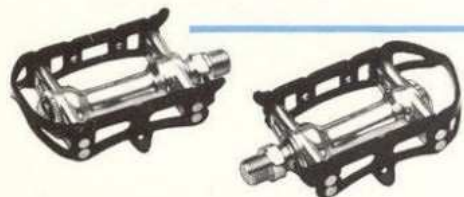
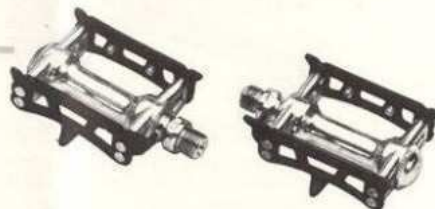

GPM CRONOSPRINT 300DD

- Pedali strada in lega • Light alloy road pedal set
- Pedales route en alliage léger
- Leichtmetal Strassenpedalen

GPM SPRINT 300SA

- Pedali strada in lega • Light alloy road pedal set
- Pedales route en alliage léger
- Leichtmetal Strassenpedalen

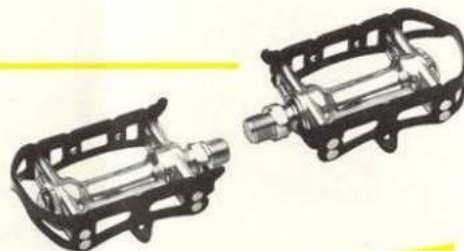

GPM CRONOSPRINT 400CA

- Mozzi strada in lega • Light alloy road hub set
- Moyeux route en alliage léger • Leichtmetal Strassenniederflanschnaben

Fori / Holes / Trous / Loecher
n. 32 36

GPM CRONOSPECIAL 400B1

- Mozzi pista in lega • Light alloy track hub set
- Moyeux piste en alliage léger
- Leichtmetal Bahnniederflanschnaben

Fori / Holes / Trous / Loecher
n. 28 32 36

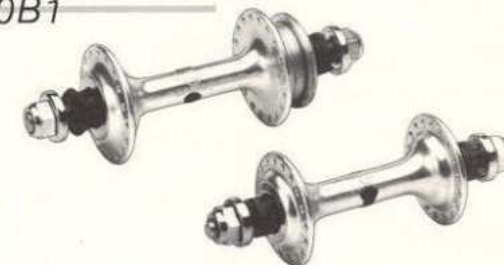

GPM CRONOSPECIAL 400B2

- Mozzi pista in lega a flange larghe • Light alloy track high hub set
- Moyeux piste à grande jeu
- Leichtmetal Bahnhochflanschnaben

Fori / Holes / Trous / Loecher
n. 28 32 36

GPM SPRINT 400SA

- Mozzi strada in lega • Light alloy road hub set
- Moyeux route en alliage léger
- Leichtmetal Strassenniederflanschnaben

Fori / Holes / Trous / Loecher
n. 36



MOZZI

HUB SET MOYEUR NIEDERFLANSCHNABEN

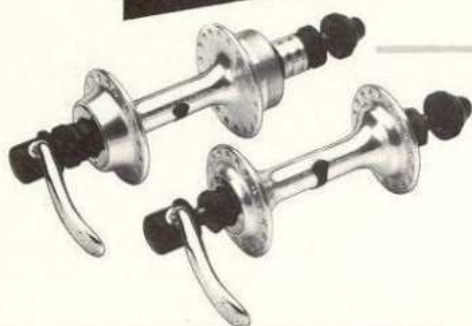

GPM CRONOSPECIAL 400BB

- Mozzi strada in lega • Light alloy road hub set
- Moyeux route en alliage léger
- Leichtmetal Strassenniederflanschnaben

Fori / Holes / Trous / Loecher
n. 28 32 36

SERIE STERZO

HEADSET JEU DE DIRECTION STEUERSATZ

GPM CRONOSPECIAL 500AA

- Serie sterzo in lega con labirinto meccanico • Light alloy headset with mechanical labyrinth
- Jeu de direction en alliage léger à labyrinthe mécanique • Leichtmetall Steuersatz mit mechanischem Labyrinth



GPM CRONOSPRINT 500CC

- Serie sterzo in lega con guarnizioni • Light alloy headset with Teflon sealing washers
- Jeu de direction avec joint spécial en fibre synthétique • Leichtmetall Steuersatz mit Teflon-Dichtungen

GPM CRONOSPRINT 500BP

- Serie sterzo in lega con guarnizioni • Light alloy headset with Teflon sealing washers
- Jeu de direction avec joint spécial en fibre synthétique • Leichtmetall Steuersatz mit Teflon-Dichtungen



GPM CRONOSPECIAL 500B1

- Serie sterzo pista in lega leggera • Track light alloy headset
- Jeu de direction piste en alliage léger • Leichtmetall Bahnsteuersatz



GPM SPRINT 500CE

- Serie sterzo in lega leggera • Light alloy headset
- Jeu de direction en alliage léger • Leichtmetall Steuersatz



FRENI

BRAKES FREINS BREMSEN

GPM CRONOSPECIAL 700AA

- Freni in lega. Perno ant. mm. 28 posteriore mm. 13 • Light alloy brakes. Front bolt mm. 28 rear bolt mm. 13
- Freins en alliage léger: axe avant mm. 28, arrière mm. 13
- Leichtmetall Bremsen. Bremsenachse mm. 28 mm. 13

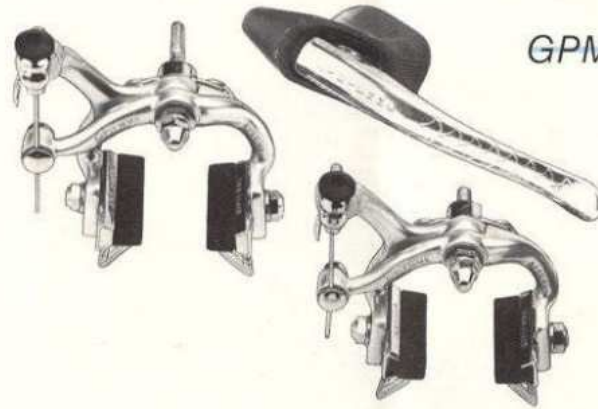
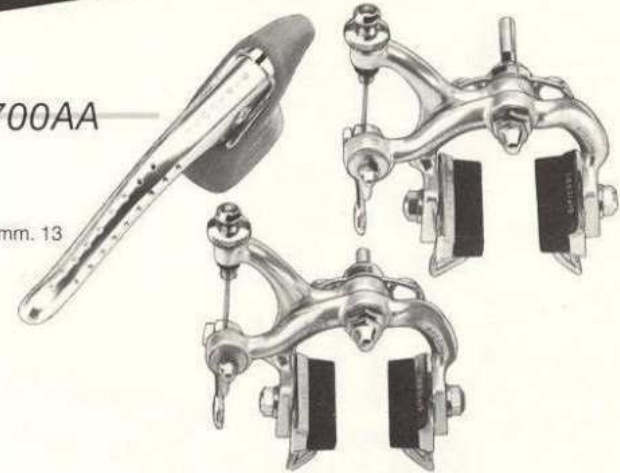

GPM CRONOSPRINT 700CA

- Freni in lega. Perno ant. mm. 28-40, posteriore mm. 13-25 • Light alloy brakes. Front bolt mm. 28-40, rear bolt mm. 13-25
- Freins en alliage léger: axe avant mm. 28-40, arrière mm. 13-15 • Leichtmetall Bremsen. Bremsenachse mm. 28-40, mm. 13-25

GPM CRONOSPRINT 700CC

- Freni in lega. Perno ant. mm. 28-40, posteriore mm. 13-25 • Light alloy brakes. Front bolt mm. 28-40, rear bolt mm. 13-25
- Freins en alliage léger: axe avant mm. 28-40, arrière mm. 13-15 • Leichtmetall Bremsen. Bremsenachse mm. 28-40, mm. 13-25

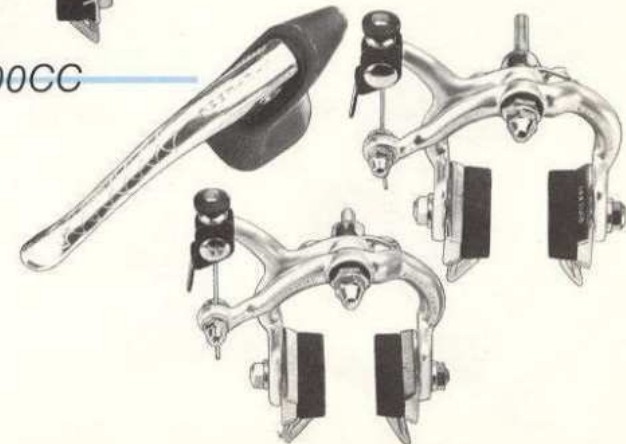

GPM SPRINT 700SA

- Freni in lega. Perno ant. mm. 28-40, posteriore mm. 13-25 • Light alloy brakes. Front bolt mm. 28-40, rear bolt mm. 13-25
- Freins en alliage léger: axe avant mm. 28-40, arrière mm. 13-15 • Leichtmetall Bremsen. Bremsenachse mm. 28-40, mm. 13-25

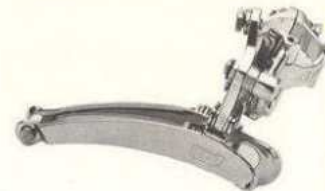

GPM SPRINT 802 DD

- Deragliatore universale a fascetta • Universal clamp-on front derailleur
- Dérailleur universel à collier • Universell Umwerfer mit schelle

GPM CRONOSPRINT 870 BC

- Coppia manetini comando a retrofrizione
- Levers • Manettes • Schalthebel



CAMBI

DERAILLEURS DERAILEURS SCHALTUNG

GPM CRONOSPECIAL 800AE

- Cambio 801 AE, deragliatore 802 AE e manetini • Selectron 870 SE
- Rear derailleur 801 AE, front derailleur 802 AE levers 870 SE
- Dérailleur arrière 801 AE, dérailleur avant 802 AE et Manettes 870 SE • Schaltung 801 AE, Umwerfer 802 AE, Schalthebel 870 SE



GPM CRONOSPRINT 800CC

- Cambio 801 CC, deragliatore 802 DD, manetini 870 DS • Rear derailleur 801 CC, front derailleur 802 DD, levers 870 DS • Dérailleur arrière 801 CC, dérailleur avant 802 DD, manettes 870 DS • Schaltung 801 CC, Umwerfer 802 DD, Schalthebel 870 DS

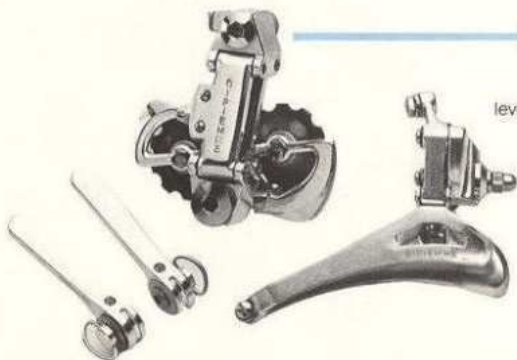

RUOTA LIBERA

FREE WHEEL ROUE LIBRE FREILAUF

GPM CRONOSPECIAL

- Ruota libera in lega leggera • Light alloy free wheel • Roue libre en alliage léger • Leicht metal Freilauf
- 906AS-907AS 6/7 • velocità • speed • vitesse • fach
- 906AA-907AA 5/6 • velocità • speed • vitesse • fach



GPM CRONOSPECIAL

- Ruota libera in acciaio • Steel free wheel • Roue libre en acier • Stahl • Freilauf
- 906CS-907CS 6/7 • velocità • speed • vitesse • fach
- 906CC-907CC 6/5 • velocità • speed • vitesse • fach



GPM CRONOSPRINT 906CE

- Ruota libera in acciaio • Steel free wheel • Roue libre en acier • Stahl • Freilauf
- 906CS-907CS 6/7 • velocità • speed • vitesse • fach
- 906CC-907CC 6/5 • velocità • speed • vitesse • fach



MANUBRI

GPM CRONOSPECIAL AA

- Realizzato in lega leggera. Diametro mm. 26
- Larghezza cm. 38, 40, 42, 44 ● Made of light alloy.
- Diameter mm. 26 Width cm. 38, 40, 42, 44
- En alliage léger. Diametre mm. 26 Largeur
- cm. 38, 40, 42, 44 ● Aus Alu-Legierung
- Rohrdurchmesser mm. 26 Breite cm. 38, 40, 42, 44

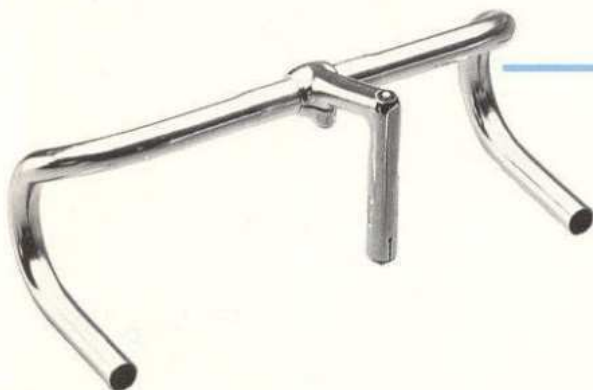
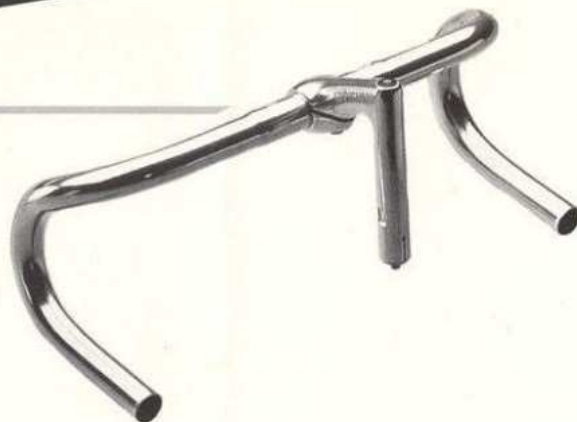

GPM CRONOSPRINT CG

- Realizzato in lega leggera. Diametro mm. 26
- Larghezza cm. 38, 40, 42, 44 ● Made of light alloy.
- Diameter mm. 26 Width cm. 38, 40, 42, 44 ●
- En alliage léger. Diametre mm. 26 Largeur
- cm. 38, 40, 42, 44 ● Aus Alu-Legierung
- Rohrdurchmesser mm. 26 Breite cm. 38, 40, 42, 44

GPM SPRINT DD

- Realizzato in lega leggera. Diametro mm. 25,7
- Larghezza cm. 38, 40, 42, 44 ● Made of light alloy.
- Diameter mm. 25,7 Width cm. 38, 40, 42, 44
- En alliage léger. Diametre mm. 25,7
- Largeur cm. 38, 40, 42, 44 ● Aus
- Alu-Legierung Rohrdurchmesser mm. 25,7
- Breite cm. 38, 40, 42, 44

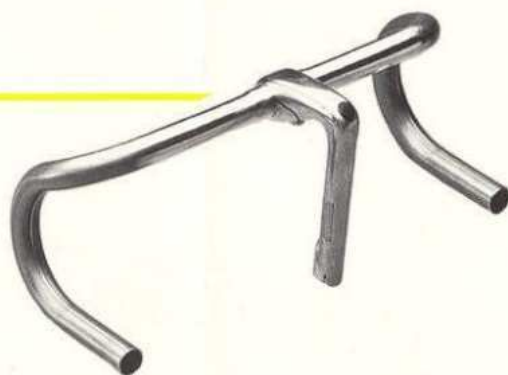

ACCESSORI

- Puntapiedi GPM cromati e puntapiedi GPM bruniti
- Gpiemme cromed toe-clips and anodized toe-clip
- Calle - pieds Gapiemme chromées et anodisées

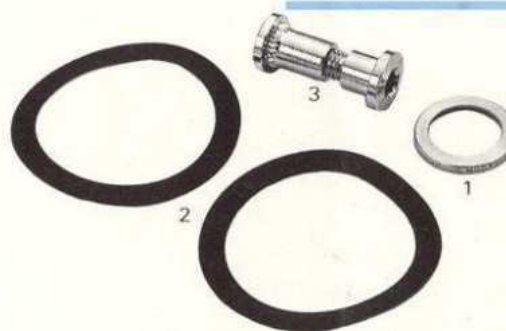

- 1) Rondella salva pedivella 2) coppia rondelle di spallamento RL 3) Dado e vite fissaggio reggisella al telaio
- 1) Special washer (GPM patent) to ensure correct locking pedal pin and crank 2) Teflon coated steel washers (GPM patent) to ensure correct locking freewheel-hub 3) Seat post binder bolt and nut
- 1) Rondelle (Brevet Gapiemme) assure blocage optimal axe pedale et manivelle 2) Rondelles acier traitées au Teflon (Brevet Gapiemme) assure parfait blocage roue libre-moyeux 3) Ecrou et boulon de blocage de selle

- Barattoli grasso speciale anti acqua gr. 100, 200, 500 e 1.000
- Gr. 100, 200, 500 and 1000 tin of water repellent grease
- Pot de graisse hermetique a l'eau gr. 100, 200, 500 et 1000
- Spezialschmierfett wasserabstossend gr. 100, 200, 500, 1000



SCATOLA MOVIMENTO

TRETLAGERGEHAEUSE
PRICE DE RACCORD POUR PEDALIERS
PEDAL BEARING HOUSING

KIT GIPIEMME 1890AA



1880 AA



1881 AA

1880 AA

1800 AA

1840 AA

1860 BB

1850 AA

ATTACCHI A SALDARE

BRAZE-ON PARTS
ANLOETEILE
ACCESSOIRES A BRASER

* 1827 AA = ACC. INOX
 * 1828 AB = ACC. INOX
 1827 CA = Acciaio
 1828 CB = Acciaio

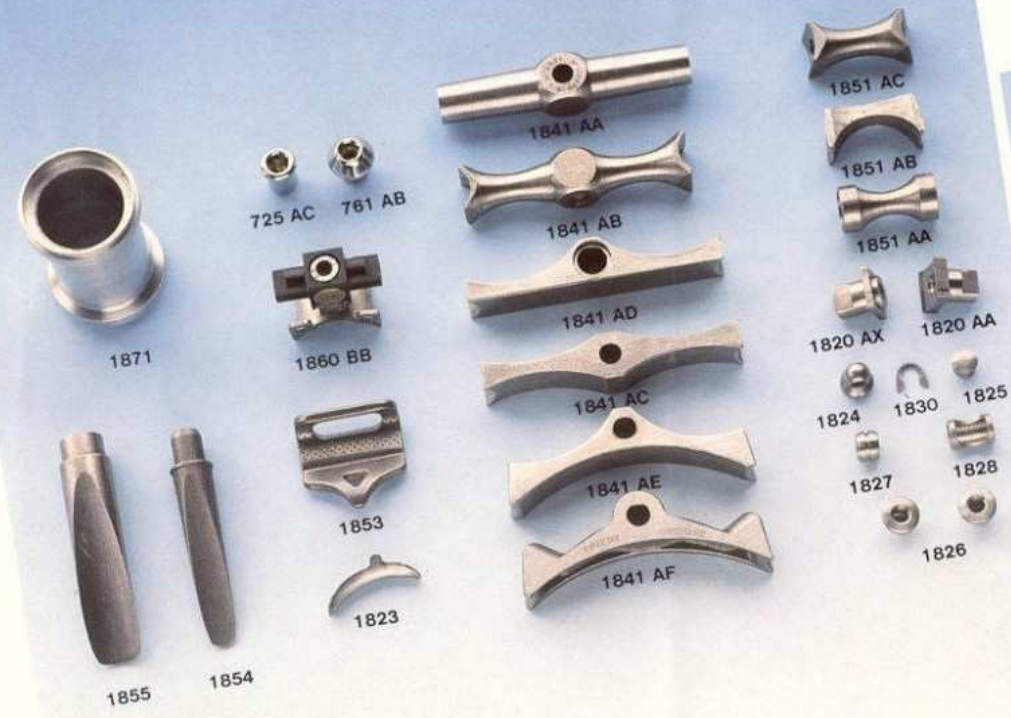

FORCELLINI

AUSFALLENDEN
FORK END SET
JEU DE PATTES





Gipiemme srl 36040 Grumolo Abbadesse Loc. Vancimuglio (Vicenza) Tel. 0444/582344 Telex 431142 GPM I



ALTA SCORREVOLEZZA PRECISIONE SICUREZZA PROTEZIONE FUNZIONALITÀ

GIPIEMME

8 times world champions